



# M3FB...LX... Series

## Modulating Control Valve for Hot Gas Control



<b>Description</b>	Valves with magnetic actuator for modulating capacity control of refrigeration units and for heat recovery.
<b>Features</b>	<ul style="list-style-type: none"> <li>• Quick positioning time (approx. 1 second)</li> <li>• High resolution (&gt; 1 : 200)</li> <li>• High rangeability</li> <li>• Hermetically sealed</li> <li>• Versatile electrical interface</li> <li>• Low friction</li> <li>• Port 1 → 3 closed when de-energized</li> <li>• Heavy-duty and maintenance-free</li> </ul>
<b>Application</b>	<p>The M3FB...LX... three-way or straight-through valves with magnetic actuator are used for modulating capacity control of refrigeration units and for heat recovery. They may be used as hot gas diverting or straight-through valves.</p> <p>Suitable for safety refrigerants such as R22, R134a, R404A, R407C and R507.</p>
<b>Product Numbers</b>	See <i>Table 1</i> .

### Warning/Caution Notations

<b>WARNING:</b>		Personal injury/loss of life may occur if a procedure is not performed as specified.
<b>CAUTION:</b>		Equipment damage may occur if the user does not follow a procedure as specified.



## Ordering

The M3FB...LX... valve and the ZM... or ZM.../A module must be ordered separately.

When placing an order, specify the quantity, product number and product description.

### Example :

1 M3FB15LX/A control valve and 1 ZM101/A module.

**Table 1. Product Numbers.**

Valve Product Number (Without ZM...)	Line Size [in]	Cv 1 → 3 [gpm]	$\Delta p_{v,max}$ 1 → 3		P <sub>N</sub> [VA]	P <sub>med</sub> [VA]
			[psi]	[bar]		
<b>M3FB15LX06/A</b>	1/2	0.7	319	22	26	6
<b>M3FB15LX15/A</b>	1/2	1.8	319	22	26	6
<b>M3FB15LX/A</b>	1/2	3.5	319	22	26	6
<b>M3FB20LX/A</b>	3/4	5.9	261	18	26	6
<b>M3FB25LX/A</b>	1	9.4	174	12	40	10
<b>M3FB32LX</b>	1-1/4	14.0	116	8	40	10

### Key :

$\Delta p_{v,max}$  = Max. admissible pressure differential

P<sub>N</sub> = Nominal power

P<sub>med</sub> = Mean operating power

Cv = Flow rate tolerance ±10 %

## Technical Design

The armature or magnetic core is designed as a floating component within the pressure system, so that no external shaft gland is required. Therefore, leakage losses common with moving parts are avoided. The valve cross-section allows for easy flow whether the valve is fully or only partially open. This reduces pressure losses and ensures quiet operation.

The valves are fitted with extended female solder unions, making pipe connections easy.

## Mechanical Design

The control signal is converted in the ZM.../A module into a phase cut signal, which generates a magnetic field in the coil. This causes the only moving part, the armature, to change its position in accordance with the interacting forces (magnetic field, counter-spring, hydraulics etc.). The armature responds rapidly to any change in signal, transferring the corresponding movement directly to the control disc, enabling fast changes in load to be corrected quickly and accurately.

The valve is normally closed. A spring closes the valve automatically if the power is switched off or fails.

## Sizing

See *Table 2*.

**NOTE:** Correct valve sizing (to ensure a sufficiently large pressure drop  $\Delta p_{v100}$  across the fully open valve) is the key to the correct operation of a refrigeration unit. All the components must be coordinated, and this can be ensured only by the refrigeration specialist.

The application examples that follow show the recommended pressure drop in each case.

### Refrigeration capacity in tons

Nominal capacity in tons at evaporation temperature  $t_c = 41^\circ\text{F}$  ( $5^\circ\text{C}$ )

**Table 2. Selection Table for Hot-Gas Applications.  
(Approximate Guide to Valve Size)**

$\Delta p_{v100}$	Valve Product Number	Refrigerant								
		R407C (R22)			R134a (R12)			R404A / R507		
		Condensation temperature $t_c$ [ $^\circ\text{F}$ ]								
		122	104	86	122	104	86	122	104	86
0.5 bar (7.2 psi)	M3FB15LX06/A	1.3	1.1	1.0	1.1	0.9	0.8	1.1	0.9	0.8
	M3FB15LX15/A	3.1	2.8	2.5	2.7	2.4	2.1	2.6	2.3	2.1
	M3FB15LX/A	6.3	5.7	5.1	5.4	4.8	4.0	5.1	4.6	4.0
	M3FB20LX/A	10.5	9.4	8.5	9.1	8.0	6.8	8.8	7.7	6.8
	M3FB25LX/A	16.8	15.1	13.7	14.5	12.5	10.8	13.9	12.2	10.8
	M3FB32LX	25.3	22.8	20.5	21.6	19.1	16.2	21.1	18.5	16.5
1.0 bar (14.5 psi)	M3FB15LX06/A	1.8	1.6	1.4	1.5	1.3	1.1	1.5	1.3	1.1
	M3FB15LX15/A	4.6	4.0	3.4	3.7	3.1	2.8	6.5	3.1	2.8
	M3FB15LX/A	8.8	8.0	7.1	7.4	6.5	5.7	7.4	6.5	5.7
	M3FB20LX/A	14.8	13.1	11.7	12.5	10.8	9.4	12.2	10.8	9.4
	M3FB25LX/A	23.6	21.1	18.8	19.9	17.4	14.8	19.6	17.4	15.1
	M3FB32LX	35.6	31.6	28.2	30.2	26.2	22.2	29.3	25.9	22.8
4.0 bar (58 psi)	M3FB15LX06/A	3.2	2.8	2.4	2.6	2.1	1.7	2.7	2.4	2.0
	M3FB15LX15/A	8.0	7.1	6.0	6.5	5.4	4.3	6.8	6.0	5.1
	M3FB15LX/A	16.2	14.2	12.0	13.1	10.8	8.3	13.7	11.7	10.0
	M3FB20LX/A	27.0	23.6	19.9	21.6	17.9	13.7	22.8	19.6	16.5
6.0 bar (87 psi)	M3FB15LX06/A	3.7	3.1	2.5	2.8	2.2	1.7	3.1	2.7	2.2
	M3FB15LX15/A	9.4	8.0	6.3	7.1	5.4	4.3	8.0	6.5	5.4
	M3FB15LX/A	18.5	15.7	12.8	14.2	10.8	8.3	15.7	13.4	11.1
	M3FB20LX/A	30.7	26.2	21.1	23.6	17.9	13.7	26.2	22.2	18.2
8.0 bar (116 psi)	M3FB15LX06/A	4.0	3.1	2.5	2.8	2.2	N/A	3.4	2.8	2.2
	M3FB15LX15/A	10.0	8.0	6.3	6.8	5.4	NA	8.5	7.1	5.4
	M3FB15LX/A	19.6	15.9	12.8	13.9	10.8	N/A	17.1	13.9	11.1
	M3FB20LX/A	32.7	26.8	21.1	23.1	17.9	N/A	28.5	23.3	18.2

$\Delta p_{v100}$  = Pressure drop across the fully open valve

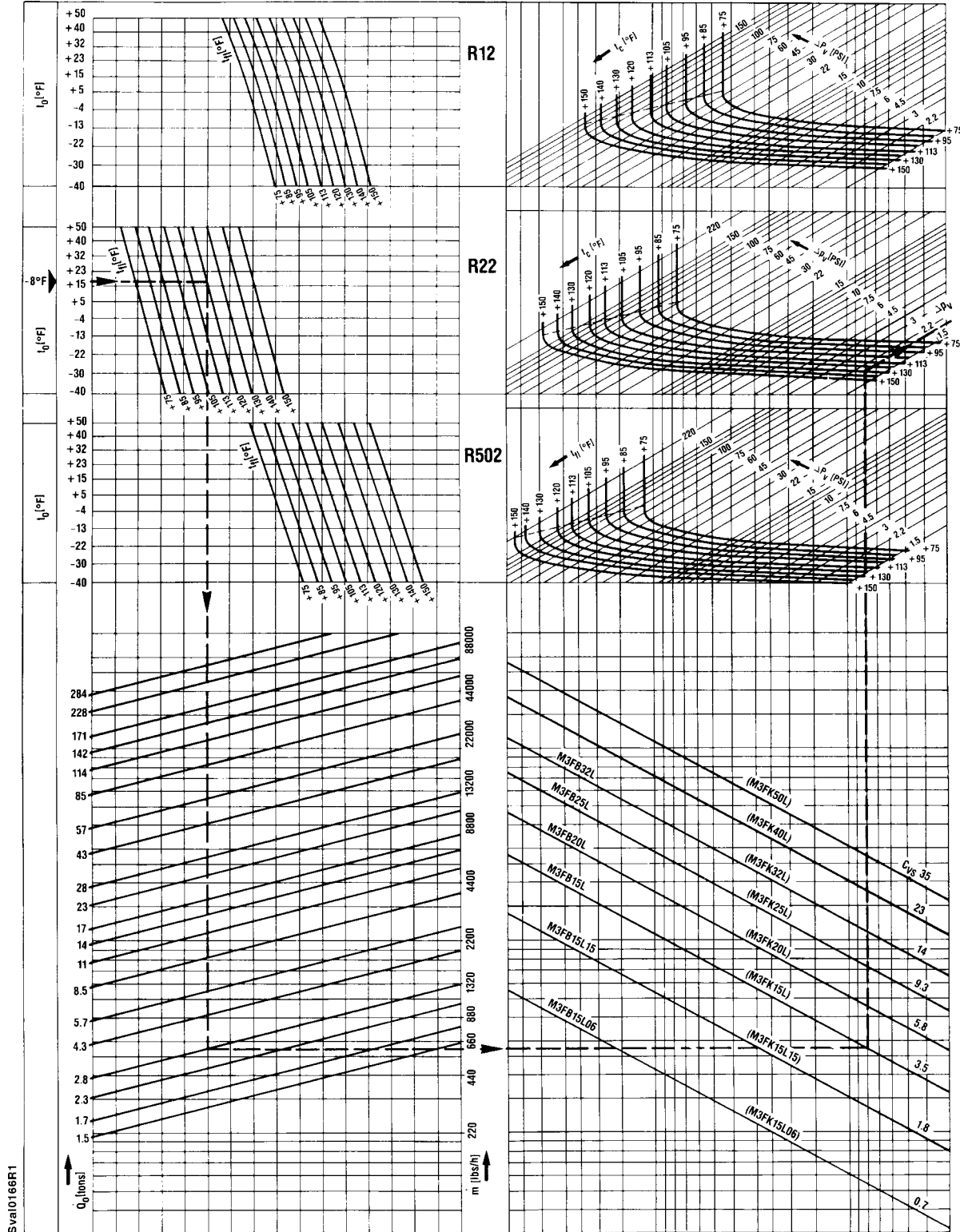

**Key :**  
 $t_0$  Evaporation temperature [°F]  
 $t_c$  Condensation temperature [°F]  
 $t_{li}$  Liquid temp. ( $t_c$  - degree of sub-cooling) [°F]  
 $Q_0$  Refrigeration capacity [tons]  
 $m$  Mass flow of refrigerant [lbs/h]  
 $C_{vs}$  Flow rate [ft<sup>3</sup>/h]  
 $\Delta p_v$  Admissible pressure differential [psi]

**Figure 1. Selection Chart for Hot-Gas Applications.**

## Mounting Notes

Mounting instructions are enclosed with the valve: Ref. 35541 (connection terminal) and Ref. 35548 (valve).

The refrigerant valves can be mounted in any orientation, but upright mounting is preferable. The pipes should be fitted so that the alignment does not distort the valve connections. Before soldering the pipes, ensure that the direction of flow through the valve is correct.

The pipes must be soldered with care. The flame should be large enough to ensure that the junction heats up quickly and the valve does not get too hot. The flame should be directed away from the valve. Cool the valve body with a wet cloth while soldering.

Port 2 must be sealed off when the valve is used in a straight-through application.



### CAUTION:

Always switch off the power supply before connecting or disconnecting the ZM... module.

## Maintenance Notes

The modulating control valves for hot gas control from the M3FB...LX... series require no maintenance.

## Specifications

### Electrical

Electrical interface:	Only admissible with low voltage (Class 2)
Control signals:	ZM101/A 0 — 10 Vdc or 0 — 20 V phase cut ZM121/A 4DC — 20 mA or 0 — 20 V phase cut ZM111 0 — 20 V phase cut
Supply voltage	24 Vac for 0 — 10 Vdc and 4 — 20 mA
Max. voltage tolerance	+15/–10 %
Nominal power	See <i>Table 1</i>
Connection terminals	Screw terminals for 12 AWG wire

### Product Specific Data

Operating pressure $p_{e,max}$	464 psi (32 bar)
Pressure differential $\Delta p_{v,max}$ 1 → 2	1 → 3 See <i>Table 1</i> 116 psi (8 bar)
Leakage: 1 → 2	1 → 3 Max 0.03% $C_v$ Max 0.3% $k_{Cv}$
Temperature of medium	–40—248°F (– 40 — 120 °C)
Valve characteristic (stroke, $k_v$ )	Linear, optimized in low opening range
Resolution $\Delta H / H_{100}$	>1 : 200 (H = stroke)
Type of operation	Modulating
Position when de-energized	1 → 3 closed
Orientation	Any
Positioning time	Approx. 1 second
Pipe connections	Extended female solder unions

### Materials (Valve Body)

Housing components	Steel and copper
Seat / inner valve	Bronze/CrNi steel

### General Ambient Conditions

Ambient temperature	–40—122°F (– 40 — 50 °C)
---------------------	--------------------------

**Specifications,  
 Continued**

**Weight and Dimensions**

See *Dimensions*

**Safety**

Conformity

Meets the requirements for CE marking

**Connection  
 Terminals**



**WARNING :** ZM.../A module used with 0 — 20 V phase cut signals:

- Do not connect 24 Vac to Terminals 1 and 2.
- Connect Terminal 5, (marked " - ") to Terminal 2 on type NKOA terminal modules.

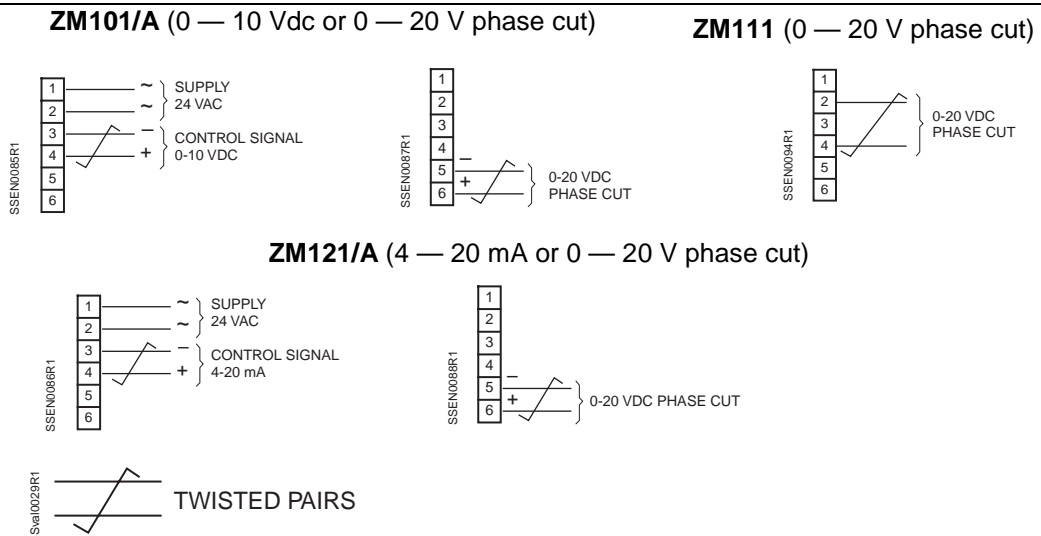

**Figure 2. Connection Terminals.**

**Application  
 Examples**

The diagrams shown here are examples only, without installation-specific details.

**Three-way Hot-gas  
 Bypass Control**

For accurate control of evaporators, from 0—100% refrigeration capacity.

- Suitable for test rooms, laboratory systems, small chilled water units and DX evaporators with a refrigeration capacity of up to approx. 11.4 tons (40 kW).

Recommended pressure drop  $\Delta p_{v100}$  across the fully-open valve (control path 1 → 3): between 7.2 and 14.5 psi (see *Figure 1. Selection Chart*).

**Application Examples, Continued**

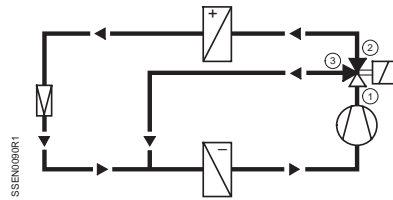

<b>Example:</b>	
Refrigeration capacity $Q_o$	6.8 tons
Refrigerant	R22
Condensation temperature $t_c$	104°F (40°C)
Evaporation temperature $t_o$	41°F (+ 5 °C)
Liquid temperature $t_{li}$	95°F (35 °C)
Selected valve	M3FB15LX/A
Pressure differential $\Delta p_v$ across valve	10.2 psi (0.7 bar)

**Figure 3. Three-way Hot-Gas Bypass Control Application.**

**Indirect Hot-gas Bypass**

The control valve throttles the capacity of a compressor stage. The hot gas is injected directly into the evaporator allowing capacity control from 100% to approximately 0%.

- Suitable for use in large refrigeration systems in air conditioning applications to prevent unacceptable fluctuations in temperature between compressor stages.

The pressure differential  $\Delta p_{v100}$  across the fully-open valve is determined by the condensation pressure at low load minus the pressure upstream of the evaporator.

If no details are provided, the pressure differential  $\Delta p_{v100}$  can be assumed to be 58 psi (4 bar).

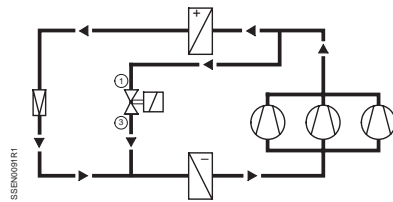

<b>Example :</b>	
Refrigeration capacity $Q_o$ of one compressor stage	8.5 tons
Refrigerant	R22
Condensation temperature full/low load	113/95°F (45/35°C)
Evaporation temperature full load/low load	41/59°F (5/15°C)
Liquid temperature $t_{li}$	81 psi (5.6 bar)
Pressure differential $\Delta p_v$ (from R22 vapor table)	M3FB15LX/A
Selected valve	Approx. 40 kW
Actual capacity	M3FB15LX/A
	Approx. 40 kW

**Figure 4. Indirect Hot-gas Bypass Application.**

**Direct Hot-gas Bypass**

The control valve throttles the capacity of a compressor stage. The gas is fed to the suction side of the compressor and cooled by a re-injection valve. Capacity control ranges from 100% to approximately 10%.

- Suitable for large refrigeration systems for air conditioning with several compressors or compressor stages, and where the evaporator and compressor are some distance apart (attention must be paid to oil return).

The pressure differential  $\Delta p_{v100}$  across the fully-open valve is determined by the condensation pressure at low load minus the suction pressure.

If no details are provided, the pressure differential  $\Delta p_{v100}$  can be assumed to be 87 psi (6 bar).

**Application Examples,  
 Continued**

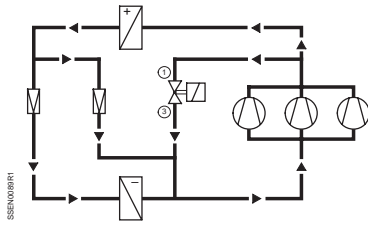

**Example:**

Refrigerant capacity of one compressor stage	11.4 tons
Refrigerant	R22
Condensation temperature full/low load	113/95°F (45/35°C)
Evaporation temperature full load/low load	36-50°F (2/10°C)
Liquid temperature $t_{fl}$	104/86°F (40/30°C)
Pressure differential $\Delta p_v$ (from R22 vapor table)	94 psi (6.5 bar)
Selected valve	M3FB15LX/A

**Figure 5. Direct Hot-gas Bypass Application.**

**Heat recovery**

The hot-gas diverting valve may be used for modulating recovery of the heat from the condenser, even in the event of high pressure differentials.

Recommended pressure drop  $\Delta p_{v100}$  across the fully-open valve (control path 1 → 3): between 0.5 and 1 bar.

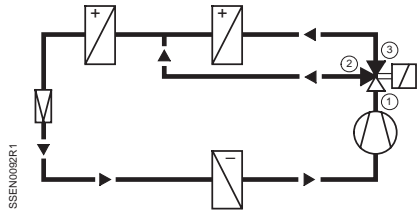

**Example:**

Refrigeration capacity Q	19.1 tons
Refrigerant	R134a
Condensation temperature $t_c$	122°F (50°C)
Evaporation temperature $t_o$	36°F (2°C)
Liquid temperature $t_{fl}$	113 (45°C)
Selected valve	M3FB32LX
Actual pressure drop	10 psi (0.7 bar)

**Figure 6. Heat Recovery Application.**



## Dimensions

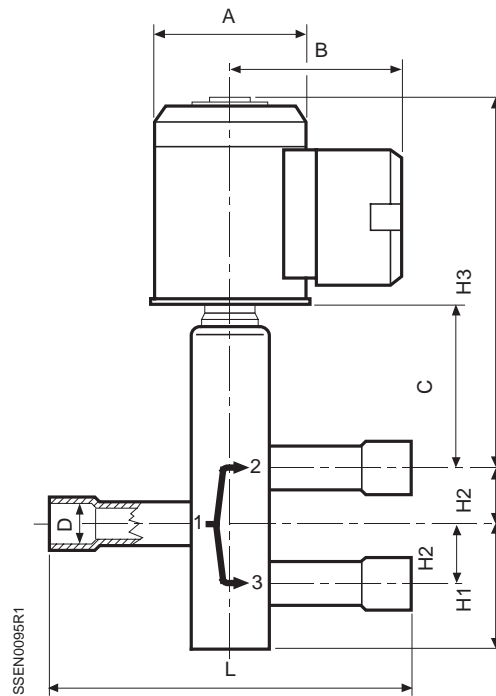

Valve Product Number	Line Size		ø D [in]	L	H <sub>1</sub>	H <sub>2</sub>	H <sub>3</sub>	A	B	C	W [lbs.]
	[mm]	[in]									
M3FB15LX06/A	15	1/2	5/8	5.91	2.56	0.98	7.24	3.15	3.31	2.64	2
M3FB15LX15/A	15	1/2	5/8	5.91	2.56	0.98	7.24	3.15	3.31	2.64	9
M3FB15LX/A	15	1/2	5/8	5.91	2.56	0.98	7.24	3.15	3.31	2.64	9
M3FB20LX/A	20	3/4	7/8	6.69	2.72	1.18	9.37	3.94	3.70	3.31	20
M3FB25LX/A	25	1	1-1/8	7.87	2.83	1.42	9.76	3.94	3.70	3.70	21
M3FB32LX	32	1-1/4	1-3/8	9.84	3.58	1.69	9.65	3.94	3.70	3.86	25

- D Pipe connections  
W Weight (including packaging)

**Figure 7. Dimensions.**

Information in this publication is based on current specifications. The company reserves the right to make changes in specifications and models as design improvements are introduced. © 2000 Siemens Building Technologies, Inc.